

1/5 Scale 4WD Electric Rally

RH522 SC5E ARTR

RH522K SC5E Kit

SC5E

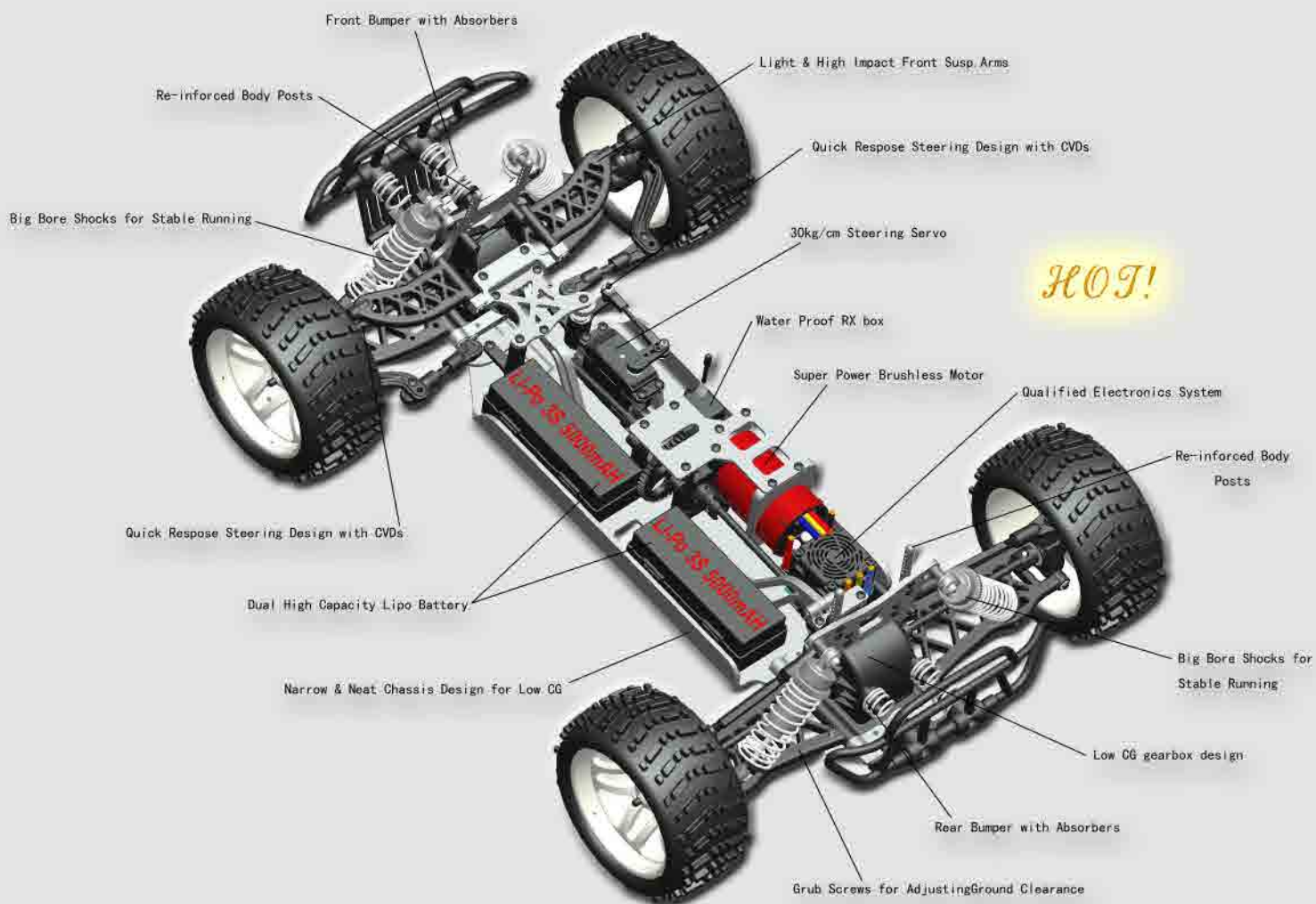

Specifications:

- 1、Length: 710 mm (SC)
- 2、Width: 510 mm (SC)
- 3、Height: 320 mm (SC)
- 4、Wheelbase: 486 mm
- 5、Gear Ratio: 11:1
- 6、Tyres: $\Phi 170 \times 80$ mm (SC)
- 7、Weight: 9000 g (SC)

System Set:

- 1、Steering Servo: 30kg/cm
- 2、Motor: 5692 (SC)
- 3、ESC: EZRUN-150A (SC)
- 4、Battery: Li-Po 5000mAh 7.4V $\leq 25^\circ\text{C}$ (SC)
- 5、Radio: 2CH 2.4GHz (SC)

RH522 Brushless System Set:



Shocks Assembly

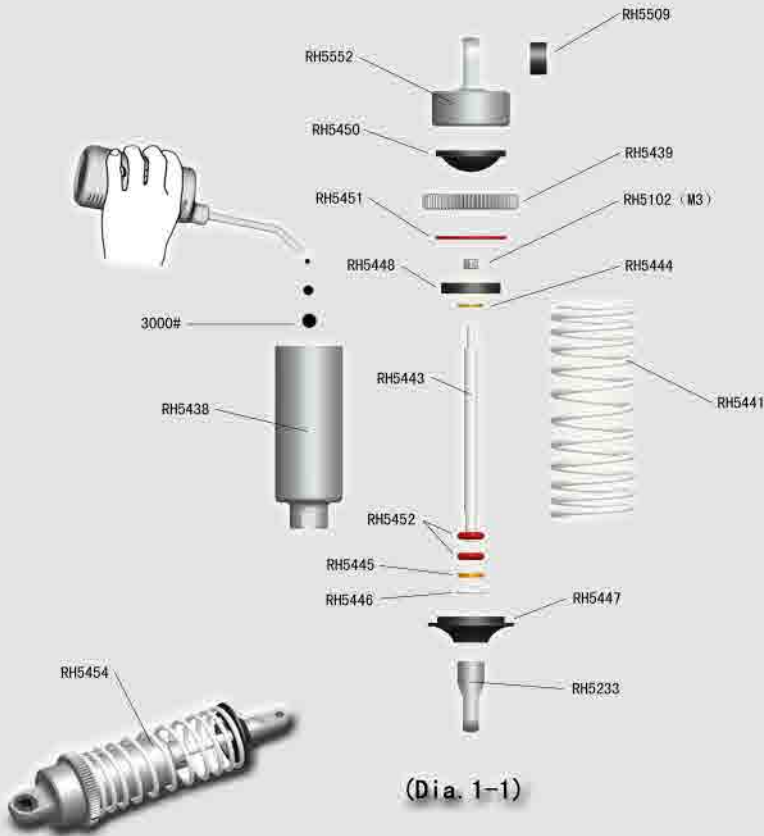

Right Tyres



Left Tyres



Chassis Assembly

B O M

TYPE	ICUN	SPEC	QTY
Nylon Lock Nut	●	M3	1
		M4	4
		M5	4
Button Head (+)	⊕	M4*10	9
		M4*16	2
Cap Head Hex Screw	⊕	M3*18	2
Self Tapping Flat Head mechanical	⊕	M4*10	8
		M4*25	2
		M5*24	4
Flat head self tapping Hex	⊕	4*10	6
Ball Bearing	○	ø9*5*2.5	4

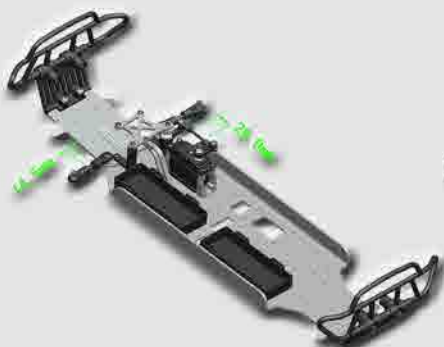

Assembly Steps

1. Make sure the Chassis Assembly is proper.
(See Dia. 1-4)



2. Screw the Front Assembly to the chassis front part. (See Dia. 2-1)



3. Screw the Front Assembly to the chassis front part. (See Dia. 2-2)

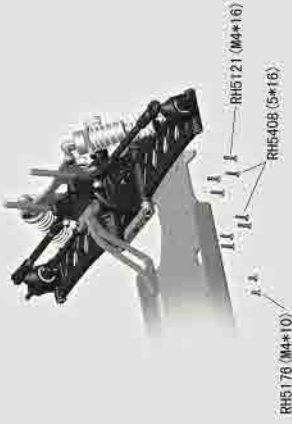

4. Assemble the receiver case on the Chassis.



5. Assemble Central Transmission Assembly and center drive shafts. (See Dia. 2-3)

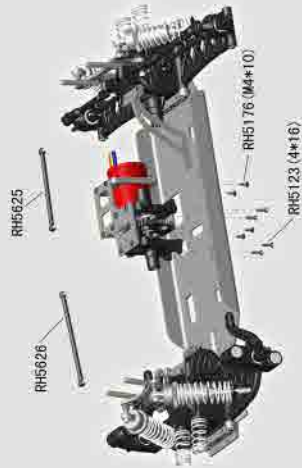

6. Assemble four wheel sets. (See Dia. 1-2, 1-3)



7. Finally assemble the electronics system and make adjustments.



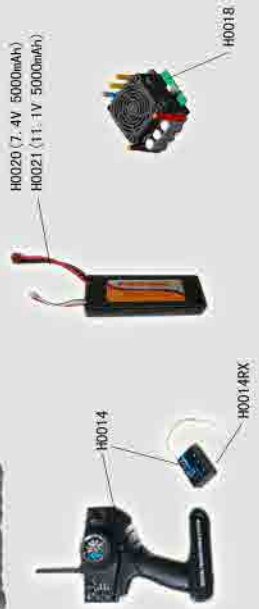













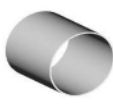
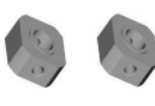





















System set:









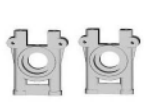



















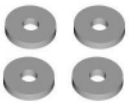





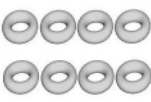



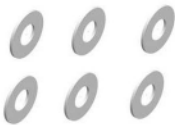

R0042 (Clear body)
R0041 (Print body)











































Parts List

<p>RH5019-Susp Arm Fixed Holder 8pcs</p> 	<p>RH5020-Diff Gearbox 1pc</p> 	<p>RH5034-Ball End for Susp. Arm 4pcs</p> 	<p>RH5035 -Steering Ball End 4pcs</p> 	<p>RH5037-Driven Diff. Gear w/Shaft 1set</p> 
<p>RH5038-Drive Diff. Gear 1set</p> 	<p>RH5039-Outer Diff. Case Cover 1pc</p> 	<p>RH5040-Wheel Rim Coupler Short 2pcs</p> 	<p>RH5041-Rear Wheel Shaft 2pcs</p> 	<p>RH5042-Diff Speed Shaft of Rear Wheel 2pcs</p> 
<p>RH5052-Rear Rim Fixing Shaft 2pcs</p> 	<p>RH5076-Steering Rod Washer 8.5*19.6*1.2 2pcs</p> 	<p>RH5077-Steering Rod Washer 6.2*18*1.5 4pcs</p> 	<p>RH5080-Washer 4pcs</p> 	<p>RH5097-Body Clip (Large Size) 6pc</p> 
<p>RH5098-Antenna Pipe 4sets</p> 	<p>RH5102-Nylon Lock Nut M3 6pcs</p> 	<p>RH5103-Nylon Lock Nut M4 6pcs</p> 	<p>RH5104-Nylon Lock Nut M5 6pcs</p> 	<p>RH5105-Nylon Lock Nut M6 6pcs</p> 
<p>RH5108-E-ring 4 mm 6pcs</p> 	<p>RH5109-E-ring 5 mm 6pcs</p> 	<p>RH5110-E-ring 7mm 6pcs</p> 	<p>RH5111-Ball Bearing 10*19*7 2pcs</p> 	<p>RH5112-Ball Bearing 8*22*7 2pcs</p> 
<p>RH5114-Ball Bearing 12*28*8 2pcs</p> 	<p>RH5117-Inner Hex Grub Screw M4*4 6pcs</p> 	<p>RH5590-Grub Screw M5*5 6pcs</p> 	<p>RH5120-Grub Screw M5*25 2pcs</p> 	<p>RH5121-FH Screw M4*16 6pcs</p> 
<p>RH5122-FH Screw M4*25 6pcs</p> 	<p>RH5123-FH Screw 4*16 6pcs</p> 	<p>RH5128-FH Screw M5x27 6pcs</p> 	<p>RH5134-Umbrella Head Screw 3*6 6pcs</p> 	<p>RH5135-RH Self Tapping Screw 4*12 6pcs</p> 
<p>RH5136-RH Self Tapping Screw 4*20 6pcs</p> 	<p>RH5139-Shock Absorber Fixing Screw 6pcs</p> 	<p>RH5167-Spacer for Shock Absorbers 4pcs</p> 	<p>RH5170-RH Self Tapping Screw M4*6 6pcs</p> 	<p>RH5174-Central Gear Bracket 2pcs</p> 

Parts List

<p>RH5176-FH Screw M4*10 6pcs</p> 	<p>RH5180-RH Screw M4*16 6pcs</p> 	<p>RH5190-E-ring M4 6pcs</p> 	<p>RH5191-Lower Susp. Arm Bracket 2pcs</p> 	<p>RH5195-Pin for Front Upper Sus. Arm 2pcs</p> 
<p>RH5196-Pin for Lower Susp. Arm Bracket 2pcs</p> 	<p>RH5197-Pin for Front Lower Sus. Arm 2pcs 2P</p> 	<p>RH5199-Front Diff Drive Cup 1pcs</p> 	<p>RH5400-Gear Box Housing 1set</p> 	<p>RH5401-Diff. Bevel Gear B. 1pcs</p> 
<p>RH5402-Diff. Bevel Gear S. 1pcs</p> 	<p>RH5407-BH Screw M5*15 6pcs</p> 	<p>RH5408-FH Screw 5*16 6pcs</p> 	<p>RH5411-Front Bumper 1pcs</p> 	<p>RH5432-Wrench 1pc</p> 
<p>RH5439-Adjusting Ring for Shock Absorber 4pcs</p> 	<p>RH5444-Shocks Absorber Gasket 4pcs</p> 	<p>RH5445-Spacer for Shock Absorbers 4pcs</p> 	<p>RH5446-Shock Absorber Clip 4pcs</p> 	<p>RH5447-Fixing of Shock Spring</p> 
<p>RH5448-Large Size Shock Piston 4pcs</p> 	<p>RH5450-Shock Piston Sealing Cap 4pcs</p> 	<p>RH5451-Shock O-ring 4pcs</p> 	<p>RH5452-Shock Absorbers O-ring 8pcs</p> 	<p>RH5458-RH Screw M4*12 6pcs</p> 
<p>RH5459-FH Screw M5*27 6pcs</p> 	<p>RH5460-Body mounts 6pcs</p> 	<p>RH5472-Wheel complete 1set</p> 	<p>RH5508-Washer 14.5* 6.5*0.8 6pcs</p> 	<p>RH5509-Spacer 4pcs</p> 
<p>RH5510-Shock upper holder 4pcs</p> 	<p>RH5512-Front upper sus. arm 2pc</p> 	<p>RH5513-Front lower sus. arm 2pc</p> 	<p>RH5514-Pivot ball nut 4pcs</p> 	<p>RH5515-Pivot ball spacer 4pcs</p> 
<p>RH5516-Pivot balls 4pcs</p> 	<p>RH5517-Steering arm 2pc</p> 	<p>RH5518-Washer 12* 8.5*2.0 4pcs</p> 	<p>RH5520-Rear Susp. arm 2set</p> 	<p>RH5521-Rear drive shaft 2pcs</p> 







Parts List

<p>RH5522-Rim stop ring 4pcs</p> 	<p>RH5523-Rear susp. arm 2pcs</p> 	<p>RH5525-M5*28 Round head screw 6pcs</p> 	<p>RH5526-Washer 15* 10.1*0.2 6pcs</p> 	<p>RH5640-Front universal joint shaft 2sets</p> 
<p>RH5552-Shock cap 4pcs</p> 	<p>RH5597-RH Self Tapping Screw 4*16 6pcs</p> 	<p>RH5630-Chassis plate 1pc</p> 	<p>RH5637-Bulkhead 1pc</p> 	<p>RH5638-Front chassis Brace 1pc</p> 
<p>RH5601-Rear Chassis Brace 1pc</p> 	<p>RH5602-Pinion gear 12T 1pc</p> 	<p>RH5603-Spur gear 1pc</p> 	<p>RH5604-Drive Shaft 1pc</p> 	<p>RH5605-Motor mount F. 1pc</p> 
<p>RH5606-Motor mount R. 1pc</p> 	<p>RH5607-Center Top Plate 1pc</p> 	<p>RH5608-Bulkhead Link 1pc</p> 	<p>RH5609-Rear Shock Tower 1pc</p> 	<p>RH5610-Front shock tower 1pc</p> 
<p>RH5611-Servo Mounts 2pcs</p> 	<p>RH5612-Rear chasis brace bracket 1pc</p> 	<p>RH5613-Steering link rod 1set</p> 	<p>RH5614-Servo spring holder 1pc</p> 	<p>RH5615-Steering Tube 1pc</p> 
<p>RH5616-Upper Servo saver arm 1pc</p> 	<p>RH5617-Lower Servo saver arm 1pc</p> 	<p>RH5618-Servo saver spring 1pc</p> 	<p>RH5619-Servo saver arm 1pc</p> 	<p>RH5620-Steering ball ends 6pc</p> 
<p>RH5621-Steering rod 1set</p> 	<p>RH5622-Servo Rod 1set</p> 	<p>RH5623-Pin 4pcs</p> 	<p>RH5624-Transmission Mount 1pc</p> 	<p>RH5625-Central drive shaft F. 1pc</p> 
<p>RH5626-Central drive shaft R. 1pc</p> 	<p>RH5627-Rim 2pcs</p> 	<p>RH5628-Tyre & foam 2sets</p> 	<p>RH5629-Steering pole 2pc</p> 	<p>85284-Battery case 1pc</p> 

Parts List

<p>85080-Steering Bellcrank Bushing 4P</p> 	<p>85137-FH Screw 3*10 6pc</p> 	<p>85173-FH Screw M3*10 6pc</p> 	<p>85175-RH Screw 3*10 8pc</p> 	<p>85181-Cap Head Hex. Screw M3*18 6pc</p> 
<p>85255-Receiver case 1set</p> 	<p>85256-400mm velcro tape 4pcs</p> 	<p>85283-BH Screw M3*6 6pc</p> 	<p>10236-E clip-8mm 4pc</p> 	
	<p>R0041-RH522 painted body 1pc</p> 	<p>R0042-RH522 clear body 1pc</p> 	<p>H0014-2.4GHz Transmitter 1pc</p> 	<p>H0014RX-2.4G RX 1pc</p> 
<p>H0020-Li-Po 5000mAh 7.4V 1pc</p> 	<p>H0021-Li-Po 5000mAh 11.1V 1pc</p> 	<p>H0018-Brushless ESC 1pc</p> 	<p>H0041-30kg/cm Servo 1pc</p> 	<p>H0042-5692 Brushless Motor 1pc</p> 

Upgraded Parts List

<p>RH5214-Diff gear box 1pc</p> 	<p>RH5217-Rear axle sleeve unit 1set</p> 	<p>RH5231-Center gear box mount 2pcs</p> 	<p>RH5233-Lower holder for shock absorber 4pcs</p> 	<p>RH5257-Alum steering arm 2pcs</p> 
<p>RH5249-Front upper susp. arm(alum.) 2pcs</p> 	<p>RH5250-Front lower susp. arm(alum.) 2pcs</p> 	<p>RH5251-Rear lower susp. arm(alum.) 2pcs</p> 